

# GHS Separationstechnik GmbH



# Company Profile

## GHS Separationstechnik GmbH

- ❖ A globally acting company founded in 2009
- ❖ Based in Landshut, Germany/Bavaria near airport Munich
- ❖ Specialist team with 30 years of experience in solid/liquid separation
- ❖ Development and manufacturing of centrifuge systems for many applications in Germany
- ❖ Service, maintenance and repair of all centrifuge systems in the market



# Company profile

Zentrifugen  
Separatoren  
Pumpen  
Service

# GHS GmbH

Engineering  
Maschinenbau  
Anlagenbau  
Reparatur

## Separationstechnik

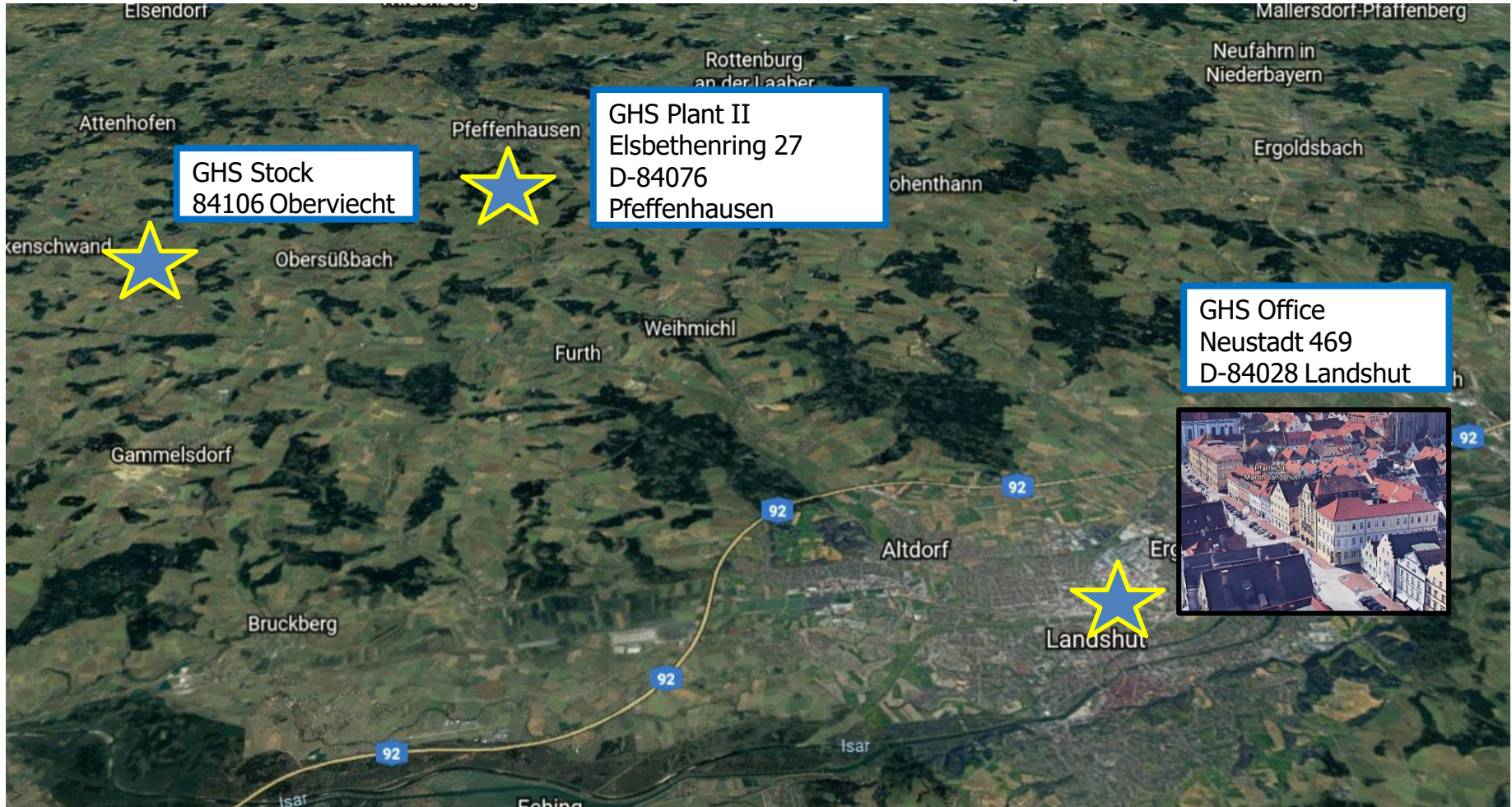

Places on 01.11.2019 (Quelle GoogleEarth)

# Company profile

GHS Office  
Neustadt 469  
84028  
Landshut

GHS Plant  
84107  
Weihmichl

Market launch  
GHT series

Market launch  
MRS together  
with L-Team

Market launch  
of SPF for  
microtunnel

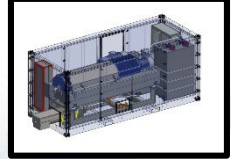
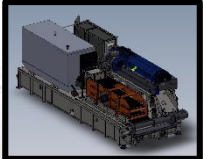

2009 2018

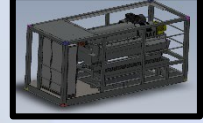
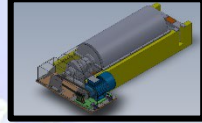
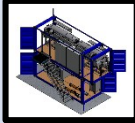
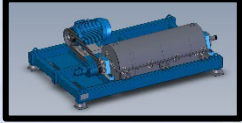

Microtunneling

Microtunneling

Geothermal

Microtunneling

Special civil  
engineering

HDD

(Quelle Logos: Googlepic.)

# Company profile

GHS additional warehouse in Oberviecht

GHS gets ISO9001:2015



GHS largest project in company history in Baku Azerbaijan

GHS new partner in Italien



GHS will partner of Netzsch



Move to 84076 Pefffenhausen



**ZUBLIN STRABAG**

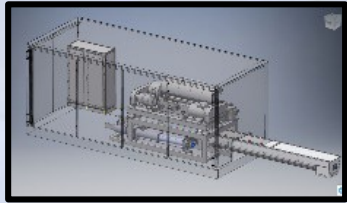

DSV

**SOCAR**

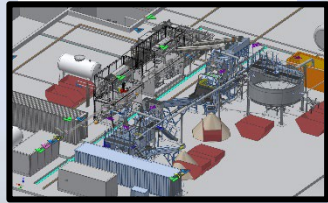

**DESS**  
Separation GmbH

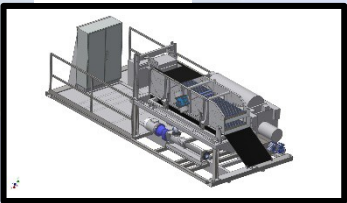

**ZUBLIN STRABAG**

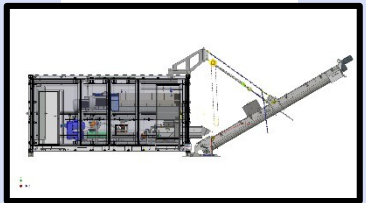

(Quelle Logos: Googlepic.)

# Company profile

## References



(Quelle Logos: Googlepic.)

# Company profile

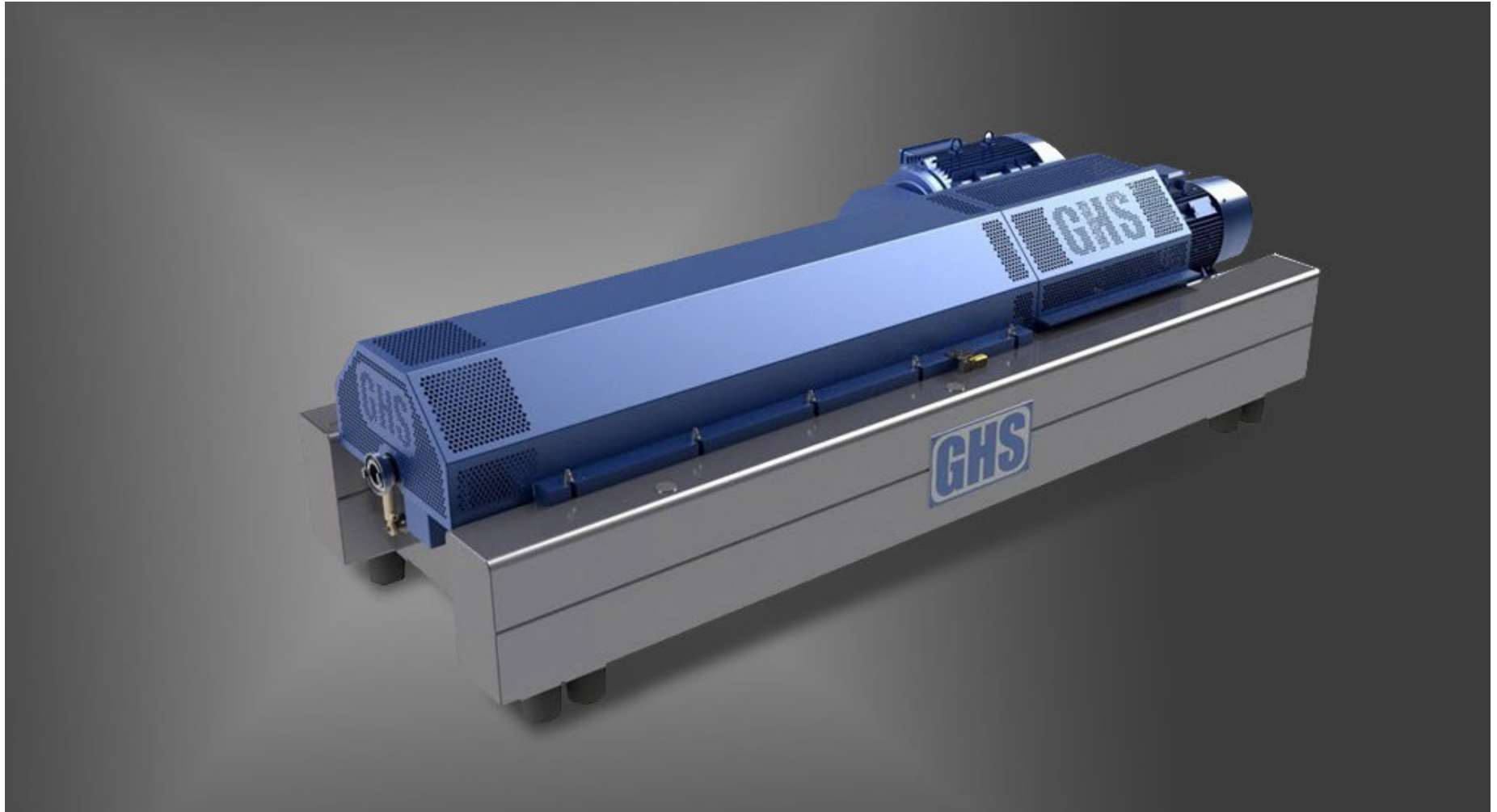





# Company profile

GHT 250



GHT 470



GHT 290



GHT 600

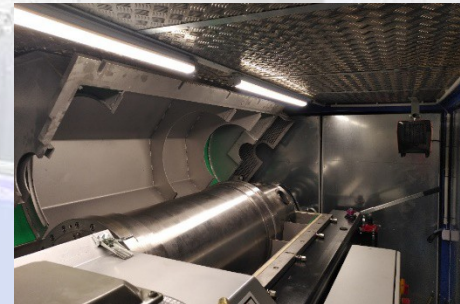

GHT 390



# Company profile

SPF150



SPF350

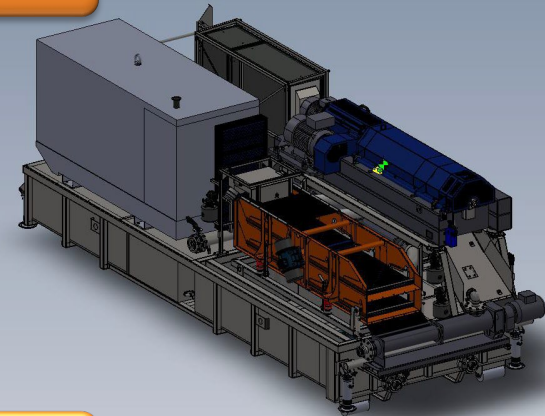

SPF470

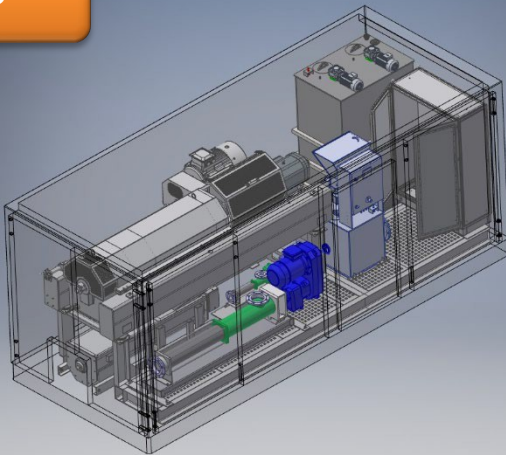

SPF600

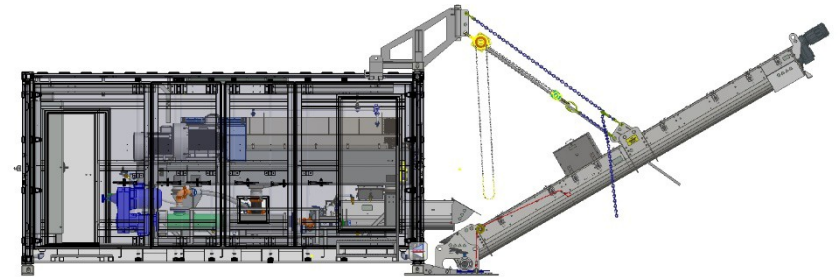

# Company profile



## SPF 150 Mini Trailer

VDBUM Award for outstanding projects 2018

**VDBUM**  
**FÖRDERPREIS**  
FÜR HERAUSRAGENDE  
PROJEKTE

**MODULARES RECYCLING SYSTEM**

**M**odulares (Bohrspilungs-)Recycling mit System (MRS) als handliche Lösung auf einem Autoanhänger für einen Sprinter als Zugfahrzeug mit eingebautem Stromaggregat

- Aufbau als mobiles, flexibles „Modulares Recycling System“ neu für den „Mini-Bohrbereich“
- Dekanterzentrifuge, optimiert für den mineralischen Einsatz
- Durchsatz je Anlage bis zu 150 l, 350 l, 600 l und 1.000 l/min
- effizienteres Arbeiten durch weniger Wassertransport
- Wiederverwendung der gebrauchten Bohrspülung
- intelligentes System für HDD, Microtunneling, Geothermie usw.



SPF 300 DSV



## SPF 350 Midi & SPF 390 Midi HP



# SPF- Serie

SPF 390



## SPF 390



➤ GHT 390\_ Baustelle Furth/ Erlangen 2017 (interra)



➤ GHT 390\_ Baustelle Villach Zentrum 2019 (Züblin)



SPF 470 Container

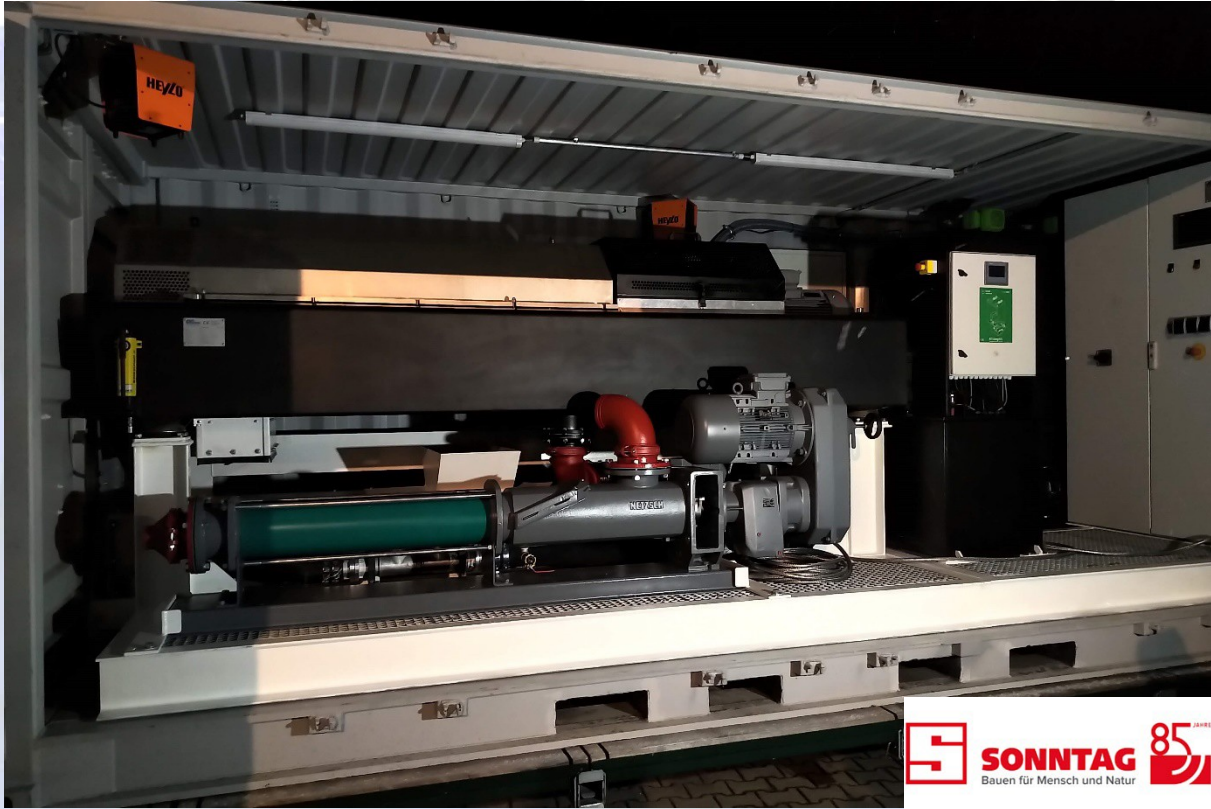

SPF 600 Container

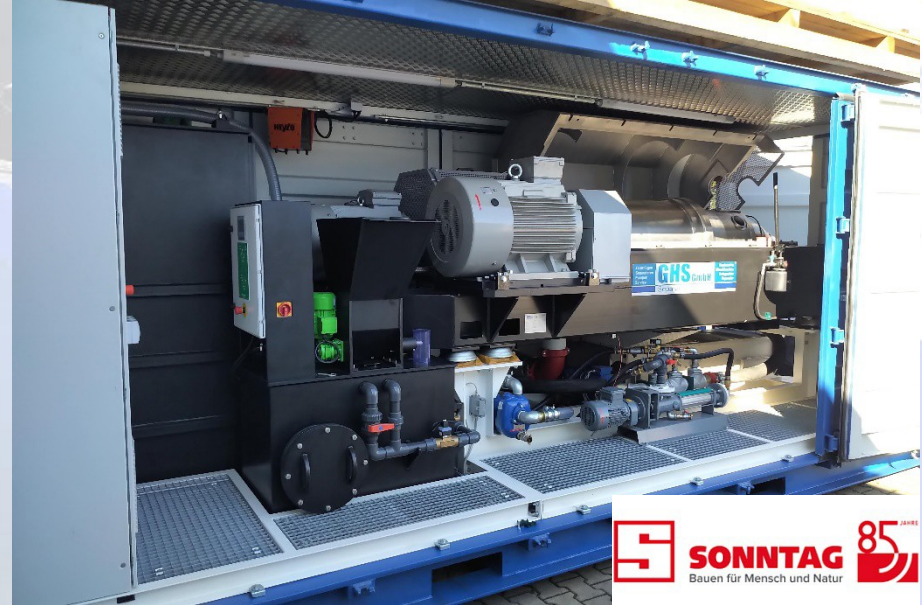
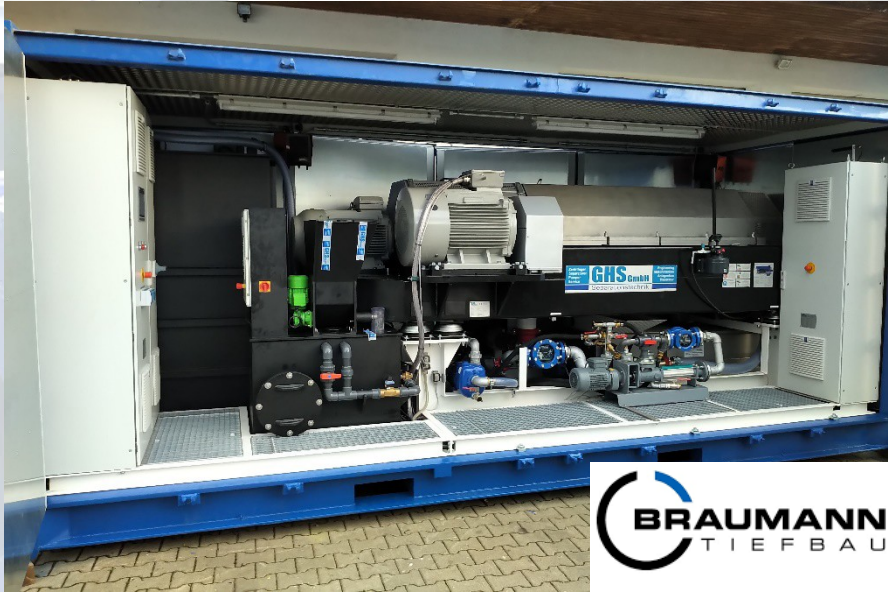

## SPF 600 Container



➤ SPF600 Container\_ Microtunnel- Baustelle Bern (CH) 2017/18

## SPF 600 DSV Container



ZUBLIN STRABAG

SPF 500 Container



➤ SPF500 Container\_ Microtunnel- Baustelle Basel(CH) 2018

## SPF 350 Container ATEX (Geothermie)

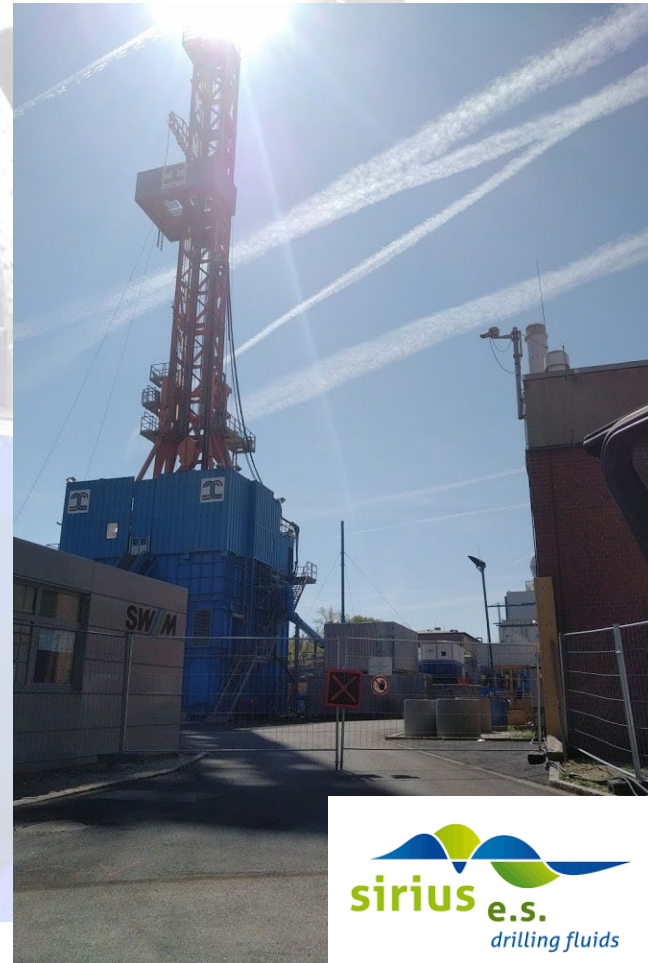

➤ GHT 350\_ Schrannehalle München 2018 (SIRIUS)

## GHT-S350 ATEX



➤ GHS- S350ATEX Taiwan 2018



## Ölschlamm- Aufbereitungsanlage ATEX





GHT CLS3000/6000

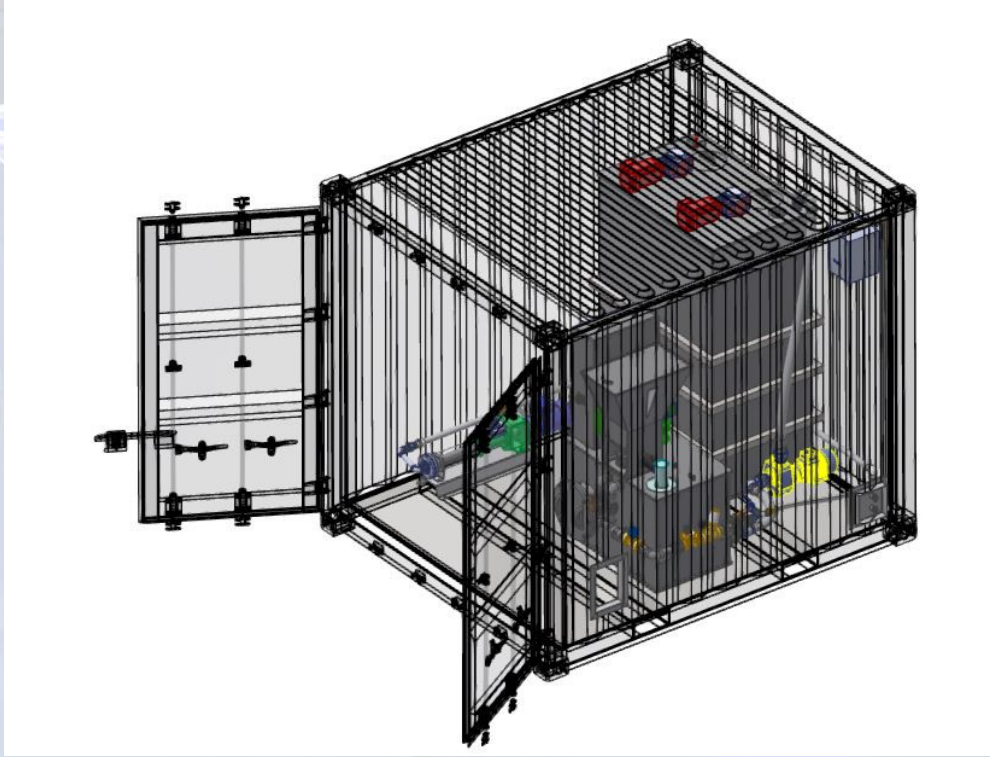

GHT CLS3000



GHT CLS6000



## Part of service references

Brand	Type	Industry	Country
➤ Andritz	CS3/3	Kaolin	Germany
➤ AlfaLaval	Lynx200	Drilling	Hungary
➤ AMC	CN300	Drilling	Germany
➤ AMC	MS-936	Drilling	Germany
➤ Bauer AG	MAT BD90	Drilling	Germany
➤ CBB	Cd25i	Waste Water	Germany
➤ CBB	Cd30i	ind. Waste Water	Germany
➤ Centrisys	18/3	Drilling	Italy
➤ Flottweg	Z4D	Drilling	Italy
➤ Flottweg	Z4E	Kaolin	Germany
➤ Flottweg	Z53	ind. Waste Water	Germany
➤ Flottweg	Z6E	Ethanol	Poland
➤ GEA	UCD205	ind.Waste Water	Austria
➤ GEA	UCD305	ind.Waste Water	Germany
➤ GEA	UCD345	ind.Waste Water	Germany
➤ GEA	UCA501	ind.Waste Water	Germany
➤ Hiller	DP45	Raps- oil	Germany
➤ Hiller	DP45 3PH	Raffinery	China
➤ Hiller	DP54	Waste Water	Germany
➤ Hiller	DP58	Waste Water	Germany
➤ Huber TEC	35	Waste Water	Germany
➤ MISwaco	i500 ATEX	Drilling	Italy
➤ Pieralisie	FD500	ind. Waster Water	Germany
➤ ...			

## Machine list

Maschinentyp	Hersteller	Eigenschaft	tec. Details in [mm]
Drehmaschine	Meuser	Konventionell	Ø800*2000
Drehmaschine	Martin	Konventionell	Ø400*1600
Fräsmaschine	Hermle	CNC	1000*400*500
Fräsmaschine	TOS	NC	600*400*600
Fräsmaschine	Mikromat	Konventionell	1400*900*900
Radialbohrmaschine	Voestalpine	Bohrkopf 360°	MK4
Säulenbohrmaschine	Flott		MK2
Bandsäge	Metallkraft	Automatic	Ø330
Bandschleifer	Metallkraft		
Schleifbock	Flott		
Tafel- Bleischere	Voestalpine		12*3000
Schwenkbiegemaschine	Easybend	manuell	2*1000
Lagerpresse	Rotex	max. 30 To	
Lagerpresse	Compac	max. 70 To	
Lagerabzieher	Betex	max. 30 To hydraulisch	
Lageranwärmgerät	SKF	induktiv	
Wuchtmaschine	Schenck		2000 1/min bei 500kg
Wuchtcomputer	Hofmann		
Probelauffundament	GHS	universal	RotorØ800*5000
Krananlage	Taucha	5 To	4000
Krananlage	Vettel	1,5 To	8000
Stapler	Steinbock	6 To	
Stapler	Steinbock_Boss	6 To	
Stapler	Linde	3,5 To	
Plasmaschneidanlager	Hypertherm		
MIG Schweißanlage	Merkle		
WIG Schweißanlage	Castolin		
Schweiß- Dreh-/Schwenktisch	MRN		1500kg

**Vielen Dank!**

Zentrifugen  
Separatoren  
Pumpen  
Service

**GHS**GmbH

Separationstechnik

Engineering  
Maschinenbau  
Anlagenbau  
Reparatur

**Benedikt Haider**

B.Eng. (FH) Maschinenbau/  
Mechanical Engineering

**GHS Separationstechnik GmbH**

Geschäftsführer/ managing director: Günter Haider

Büro/ Office: Neustadt 469, D-84028 Landshut

Produktion/ Production: Oberndorfer Str. 8, D-84107 Weihmichl

Tel.: +49 871 9750323 -0; Fax.: +49 871 9750323 -7; Mob.: +49 151 17439584

E-Mail.: [b.haider@ghsgmbh.de](mailto:b.haider@ghsgmbh.de), Web.: [www.ghsgmbh.com](http://www.ghsgmbh.com)

Bankverbindung: VR Bank Landshut eG; Konto Nr.1550705;BLZ: 743 900

00; BIC. GENODEF 1LH1

IBAN. DE 40743900000001550705; Finanzamt Landshut USt-ID-Nr. DE267021290

Handelsregister B Landshut, HRB 7908